

CUSTOMER SIGNATURE

修改日期 DATE	版次 VERSION	變更內容 REVISION

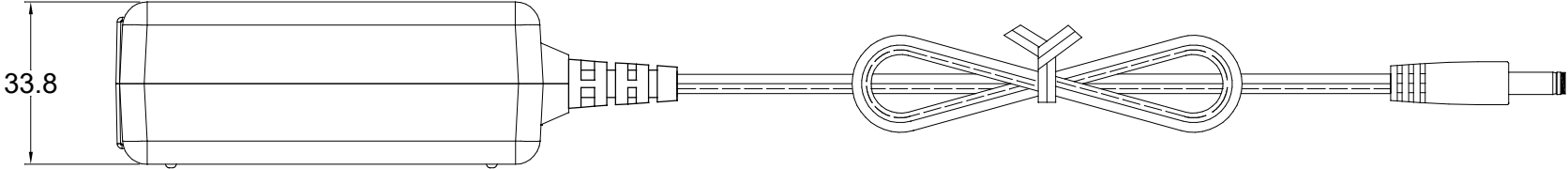

3~5V: UL2468 18AWG 1000mm  
 5~8V: UL2468 20AWG 1000mm  
 8~11V: UL2468 22AWG 1220mm  
 11~58V: UL2468 24AWG 1830mm

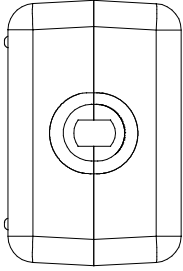
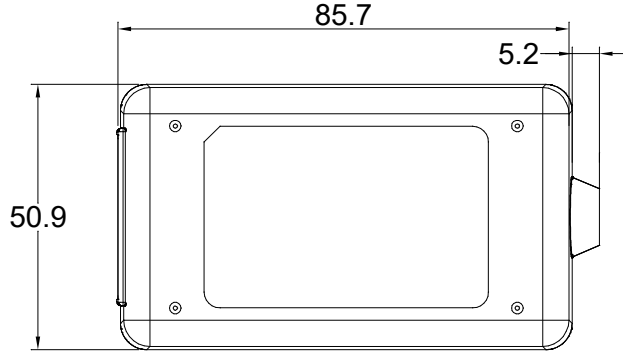
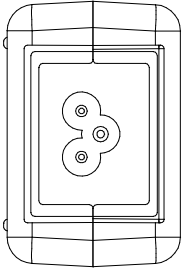

IEC-320-C6

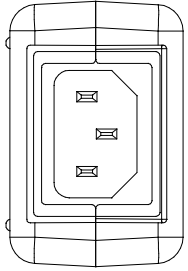

IEC-320-C14

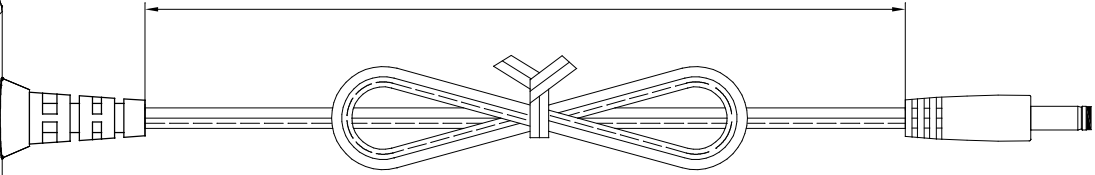
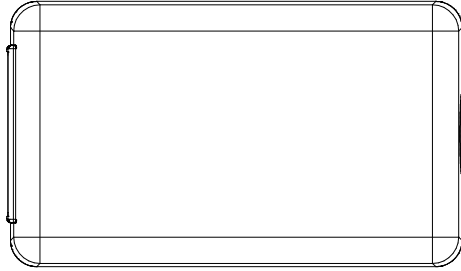

育鉦科技股份有限公司 ELJINTEK, INC.	繪圖 DWG.BY.	校對 CHK.BY.	安規人員確認 Agency approvals CHK.	承認 APP.BY.	TOLERANCE	材質 MATERIAL	圖稱 DWG.TITLE	日期 DATE	MODEL			APSU15	
							Outline drawing	比例 SCALE	NONE	單位 UNIT	m/m	正式圖面 Final DWG.	圖號 DWG.NO.
						處理 FINISH		修訂 REVISION	0	角位 ANGLE		非正式圖面 Temporary DWG.	編號 SERIAL